

User Guide

iTec XT and iTec XTR



The English language is used for the original instructions.
Other languages are a translation of the original instructions.
(Directive 2006/42/EC)

© Copyright Thermia AB

Table of Contents

1	Foreword	5
2	Safety precautions	6
	2.1 Important information	6
	2.2 Installation and maintenance	7
	2.3 Safety zone for outdoor unit iTec XTR	8
	2.4 Service	9
	2.5 Safety valves	9
3	About your heat pump	10
	3.1 Components and functions	10
	3.1.1 Heating	10
	3.1.2 Hot water	10
	3.1.3 Defrost	10
	3.1.4 Cooling	11
	3.1.5 Auxiliary heat	11
	3.1.6 Heating system flow control	12
4	Control system	13
	4.1 Navigation pad	14
	4.2 Indicator	14
	4.3 Display	14
	4.4 Main Menu	16
5	Settings and adjustments	17
	5.1 Setting operating mode	17
	5.2 Adjusting the indoor temperature	18
	5.3 Distribution circuit 1 and 2	21
	5.4 Hot water mode	21
	5.5 Cooling	21
	5.6 Reading of temperatures	22
	5.7 Reading the operating time	22
	5.8 Calendar	22
	5.8.1 Setting of temperature reduction during night and day	23
	5.8.2 Setting of calendar function (date and time)	23
	5.8.3 Setting of hot water, EVU or POWER LIMITATION, silent mode and temperature reduction	24
	5.9 Alarm history	25
6	Regular checks	26
	6.1 Checking operation	26
	6.2 Check the supply line water pressure in the heating circuit	27
	6.3 Checking safety valves	27
	6.4 In the event of leakage	27
	6.5 iTec XT: In the event of leakage of R32 refrigerant	28
	6.6 iTec XTR: In the event of leakage of R290 refrigerant	28
	6.7 Cleaning the strainer for the heating circuit	28
	6.8 Maintenance and cleaning of the outdoor unit	29
7	Default setting in the control computer	30
8	Installation protocol	31



9	Checklist	32
10	Service schedule	33

1 Foreword

Buying a heat pump from Thermia is an investment in a better future.

A Thermia heat pump is classed as a renewable energy source, which means that it is considerate of our environment. It is a safe and convenient solution that provides heating, hot water and in certain cases cooling, for your home at a low cost.

We thank you for the confidence that you have shown in us by buying a heat pump from Thermia. We hope that you will benefit from it for many, many years to come.

With best wishes

Thermia Heat Pumps

2 Safety precautions

2.1 Important information

Warning

The front of the indoor and outdoor unit must only be opened by qualified installers.

Warning

This appliance can be used by children aged 8 years and above, and by persons with reduced physical, sensory or mental capabilities or lack of experience or knowledge, provided that they are supervised or have been instructed in the safe use of the appliance and understand the hazards involved.
Cleaning and user maintenance must not be carried out by children, except under adult supervision.

Warning

Children are not permitted to play with the product.

Warning

Do not use the outdoor or indoor unit for any other purpose than what it is intended for.

The system can be considered maintenance-free but certain checks are necessary. Contact your installer for any service work.

2.2 Installation and maintenance

Caution



Only qualified installers may install, operate and carry out maintenance and repair work on the indoor and outdoor unit.

Caution



Only qualified electricians may do electrical installation and maintenance on the indoor and outdoor unit.

Caution



Only qualified refrigeration technicians may work on the outdoor unit refrigerant circuit.

Caution



The appliance shall be stored and installed so as to prevent mechanical damage from occurring.

2.3 Safety zone for outdoor unit iTec XTR

This appliance is charged with R290, a flammable refrigerant. It is important to be aware of the safety zone around the outdoor unit. Always keep this area free from open flames and ignition sources such as barbeque grill, lit cigarettes and so on.

Warning



Keep the area around the outdoor unit ignition free and free from open flame. See measures in the picture below.

Unit: mm

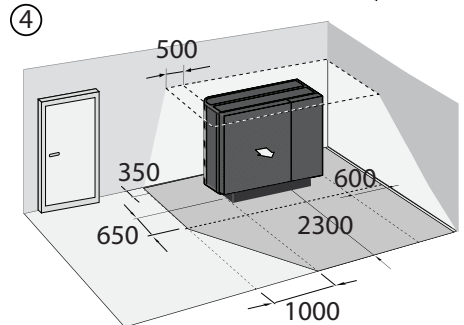
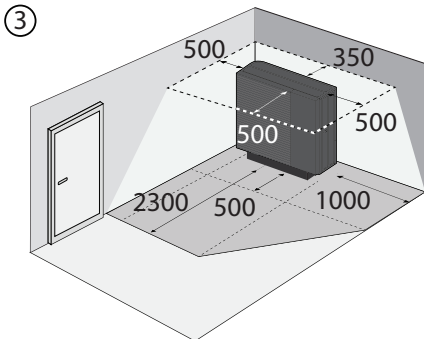
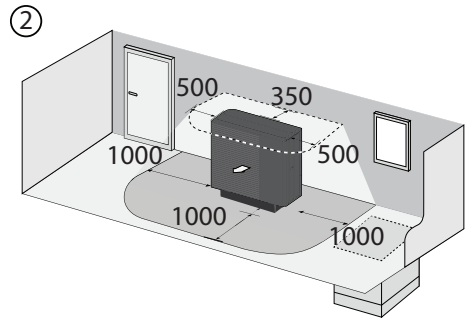
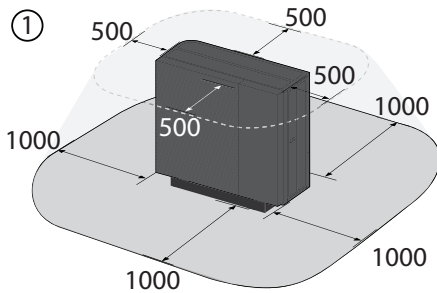

2.4 Service

Only qualified personnel may do service on the following components:

- The outdoor and indoor units
- The refrigerant circuit
- The power supply
- The safety valves

It is not permitted to carry out construction modifications that may affect the operational safety of the heat pump.

2.5 Safety valves

- Never block the connection to a safety valve's overflow pipe.
- The following safety precautions apply to the hot water circuit's safety valve with corresponding overflow pipe: Water expands when it is heated, which means that a small amount of water is released from the system via the overflow pipe. The water that exits the overflow pipe can be hot! Therefore, allow it to flow to a floor drain to prevent any risk of burning yourself or others.

3 About your heat pump

3.1 Components and functions

3.1.1 Heating

The heat pump can produce heat for heating (house, pool) and hot water.

The heat pump installation consists of two units: a heat pump placed outdoors and a control unit placed indoors. Both can be used in an existing heating system that is to be upgraded and in new builds. Heating and cooling are supplied to the house via a water borne system.

3.1.2 Hot water

iTec Compact, iTec XT Total and iTec XT Total EQ are adapted for hot water production. Production of heating, cooling and hot water cannot occur at the same time. Hot water production is prioritised before heating and cooling.

iTec XT Compact, iTec XT Total and iTec XT Total EQ have integrated 180 litre tanks equipped with a TWS coil (Tap Water Stratificator) which gives more effective heat transfer and efficient layering of water.

Using a regular time interval (NOT active in COMPRESSOR mode), the water in the tank is given extra heat by the integrated immersion heater to prevent the build up of bacteria, an anti-legionella function. The factory set time interval is seven days (can be adjusted).

The hot water requirement is prioritised before the heating requirement. The heating requirement is calculated from outdoor temperature and set heat curve. An auxiliary heater starts automatically on demand, if installed.

3.1.3 Defrost

During operation the outdoor units' air heat exchanger is cooled by the energy exchange, at the same time the humidity causes it to become covered in frost at low outdoor temperatures. iTec XT has an automatic function to defrost the air heat exchanger using the energy from whatever heat source is currently active.

Defrosting is initiated by low temperature in the refrigerant circuit after the air heat exchanger and, among other things, is dependent on outdoor temperature, humidity and operating time. The length of defrosting varies depending on the extent of freezing of the air heat exchanger. Defrost continues until the air heat exchanger is free of ice and the temperature starts to rise in the refrigerant circuit. After completed defrosting the heat pump returns to the operating mode before defrosting.

Warning

Do not interfere with any external assistance, such as open flame or mechanical help, during the defrost cycle.

Warning

There is an outdoor temperature sensor on the back side of the outdoor unit. It is of utmost importance that it is not tampered with or moved. That could cause the defrost function to fail and inflict damage to the unit.

3.1.4 Cooling

Cooling function is started by the indoor control unit and is primarily temperature controlled. The house's heating system is cooled by transferring heat to the refrigerant circuit, which is then given off in the air heat exchanger of the outdoor unit.

If the hot water heater is installed, the control unit will alternate between cooling and hot water production with prioritisation for the hot water requirement.

3.1.5 Auxiliary heat

The auxiliary heater is included in iTec XT Plus, iTec XT Compact, iTec XT Total and iTec XT Total EQ. An auxiliary heater consists of an immersion heater, which is located on the supply line before the reversing valve.

If in AUTO mode, the auxiliary heater automatically starts when the heat demand is greater than the heat pump's capacity.

Immersion heaters in iTec XT Plus, not valid, iTec XT Total and iTec XT Total EQ intended for 400V supply have three heating elements (IMM.HEAT 1, 2 and 3) and can be controlled in five power stages.

Products for 230V have two heating elements (IMM. HEAT 1 and 2) and are controlled in three power stages.

The two stages 4 and 5 cannot be engaged when the compressor is in operation as opposed to stages +4 and +5 where it is possible.

3.1.6 Heating system flow control

A heating system requires certain conditions in order to be able to run as efficiently as possible. The temperature difference between the heating system's supply line and return line should strive to be between 5–10°C. If the difference is greater or less, the heat pump is less efficient and savings are lower.

The speed controlled circulation pump in iTec XT Plus, iTec XT Compact, iTec XT Total and iTec XT Total EQ always ensures that the temperature difference is retained. The control system detects if the balance is upset and increases or decreases the speed of the circulation pump as necessary.

4 Control system

The indoor unit has an integrated control system which automatically calculates the heating and cooling demand in the house to ensure that the correct amount of heating and cooling is produced and emitted where necessary.

The control panel is operated using a navigation pad and information is shown in the display.



The information in the display and menus will vary depending on the menu selection made and connected accessories.

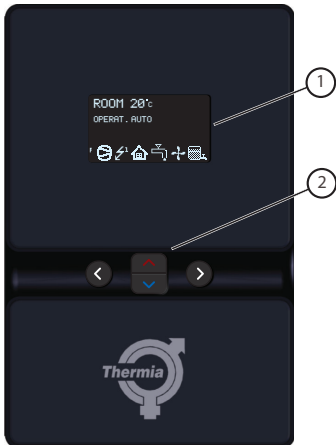

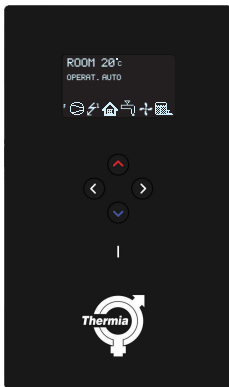

1. Display
2. Navigation pad





Display as seen on iTec XT Standard and iTec XT Plus cabinets

4.1 Navigation pad

 button used to scroll up a menu and/or increase a value.

 button used to scroll down a menu and/or decrease a value.

 button used to select a value or open a menu.

 button to cancel selection or exit a menu.









4.2 Indicator





The indicator at the bottom of the control panel has three modes:

- Not lit, means that the heat pump is not powered.
- When the green light shines continuously, the heat pump has power and is ready to produce heat, cooling or hot water, if not in OFF mode.
- Flashing green, means an active alarm.

4.3 Display

The display shows information about the heat pump's operation, status and any alarms.

Symbol	Meaning	Description
	COMPRESSOR	Indicates that the compressor is in operation.
	LIGHTNING	Indicates that the auxiliary heater is in operation. The number indicates what additional step is activated.
	HOUSE	Indicates that the heat pump produces heat.
	TAP	Indicates that the heat pump produces heat for the water heater.
F	FLOW SENSOR	Indicates that there is flow through the outdoor unit.
	CLOCK	Indicates that tariff control is active.
	TANK	Indicates the level of hot water in the water heater. When hot water is produced for the water heater, this is indicated by a flashing icon for the tank.
	TANK and LIGHTNING	A lightning symbol by the tank symbol indicates peak heating charging in domestic hot water tank (anti-legionella function).
	DEFROST	Displayed when defrosting is active.
+	FAN	Displayed when the fan is active.

Sym- bol	Meaning	Description
	COOLING	Indicates that the heat pump produces cooling.
	POOL	Indicates that the heat pump produces pool heating.
	OUTDOOR TEMP	Shows the outdoor temperature inside the cloud during screen saver mode.
	DCM ACCESSO- RY INSTALLED	Shows that DCM or Thermia Connect accessory is connected.
	ONLINE CON- NECTION	Shows that DCM or Thermia Connect accessory is connected, and has internet connection.

The following operating information may also appear:

Message	Meaning
ROOM	Shows the set ROOM value. Standard value: 20°C. If the accessory room sensor is installed it shows the actual temperature and the desired indoor temperature is shown within brackets.
START	Indicates that there is a need for heat production or hot water and that the heat pump will start.
EVU STOP	Indicates that the additional function EVU is active. EVU is used to switch off the heat pump during high energy tariffs.
NO HEAT DEMAND	Indicates that there is no heating or hot water production demand.
NO COOLING DEMAND	Indicates that there is no cooling demand.
COMPRESSOR START -- XX	Indicates that there is a need for heat, hot water or cooling and that the heat pump will start in XX minutes.
COMPRESSOR +IMM.HEAT	Indicates that heat production is active with both compressor and auxiliary heater.
START_MIN	Indicates that there is a demand for heating or hot water production but that a start delay is active.
AUX. HEATER	Indicates that there is an auxiliary heater demand.
ACT COOLING	Displayed if cooling is active.
DEFROST	Displayed when defrosting is active.
ZONE STOP	Displayed when there is no heating demand due to closed zones.
POWER LIMITATION	Indicates that the additional function Power Limitation is active. Power Limitation is used to set a maximum power consumption for the heat pump during high energy tariffs.

4.4 Main Menu

The display's INFORMATION menu is used to set and adjust the heat pump functions and is opened by pressing the left or right buttons. The appearance of the menu will vary depending on the menu selection made and connected accessories. The basic menu appears as follows:

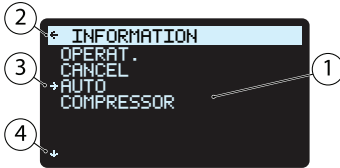

1. Sub-menus
2. Return
3. Cursor
4. If an arrow is shown, it indicates that more sub menus are continued underneath

Press the + and - buttons to move the cursor between the sub-menus. Press the right button to select a sub-menu. Press the left button to go back in the menu.

5 Settings and adjustments

The installer carries out the basic settings of the heat pump at installation. A number of settings and adjustments that you can carry out yourself are described below.



Before changing the control computer's settings, first find out what these changes mean. Make a note of the default setting.

5.1 Setting operating mode

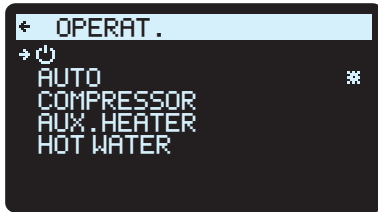

1. Open the menu OPERAT. in the INFORMATION menu. The asterisk shows the current selection
2. Mark new mode using up or down button.
3. Press the right button once to confirm the choice.
4. Press the left button twice.

The following operating modes can be selected:

Operating mode	Meaning
 (OFF)	The installation is fully switched off. This mode is also used to acknowledge and reset alarms.
AUTO	The heat pump automatically controls the compressor operation and auxiliary heater (if installed and activated in the system). AUTO mode is recommended.
COMPRESSOR	The control system is controlled so that only the outdoor unit (compressor) is allowed to operate. In this operating mode there won't be any auxiliary heating backup, if there's a need for it and also peak heating charging (anti-legionella function) of the hot water will not run because the auxiliary heater is not used.
AUX. HEATER	The control system only permits the auxiliary heater to be in operation (if installed and activated in the system).
HOT WATER	In this mode the heat pump only produces hot water. No heat is supplied for space heating.

Warning

During winter, when it is risk for freezing, the unit should only be set to **OFF** for very short periods of time. **AUTO** is the recommended setting during wintertime.

Warning

If any operation mode other than AUTO or AUX. HEATER is to be used during the winter season, the water in the heating system must be drained. Otherwise any alarms triggered that will cause the outdoor unit to stop might lead to **freezing damage** to the system. During winter, when it is risk for freezing, the unit should only be set to OFF for very short periods of time. AUTO is the recommended setting during wintertime.

5.2 Adjusting the indoor temperature

The indoor temperature is adjusted by changing the heat curve, which is the control system's tool for calculating the heating demand, the integral value. The integral value is determined by comparing the actual temperature of the heating system's supply line with the calculated value, the setpoint value. The heating requirement is calculated from the current outdoor temperature and heat curve setting.

The heat curve will be adjusted in connection with installation. It may be adapted later on, however, to obtain a pleasant indoor temperature in any weather conditions. A correctly set heat curve reduces maintenance and gives energy efficient operation.

There are two ways of adjusting the heat curve, partly in the HEATING sub-menu, partly with the ROOM value.

Adjusting CURVE

A typical heat curve is shown below. When the outdoor temperature is 0°C the heat pump control tries to make the temperature in the supply line 40°C. At hotter or colder outdoor temperatures than 0°C the set point that the control regulates against is lowered or raised respectively. When you increase the CURVE value, the heat curve will become steeper and when you decrease the CURVE value, the heat curve will become flatter. This is the most energy and cost efficient way to set the indoor temperature and should therefore be used for long term temperature settings.

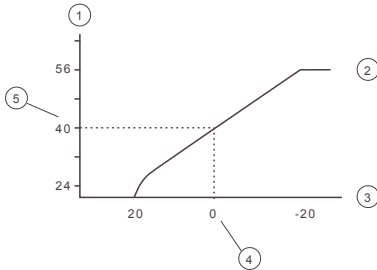

1. Supply temperature (°C)
2. Maximum setpoint value
3. Outdoor temperature (°C)
4. 0°C
5. Set value (standard 40°C)

The following parameters can be adjusted in the HEATING menu:

Parameter	Description
CURVE	If the CURVE value is increased, the heat curve will become steeper and if the value is decreased, it will become flatter. Raise or lower as necessary to obtain as even indoor temperature as possible.
MIN	Lowest set point for supply temperature.
MAX	Highest set point for supply temperature.
CURVE +5	Used to adjust the heat curve at an outdoor temperature of +5°C.
CURVE 0	Used to adjust the heat curve at an outdoor temperature of 0°C
CURVE -5	Used to adjust the heat curve at an outdoor temperature of -5°C.
HEAT STOP	This function stops all production of heat when the outdoor temperature is equal to, or higher than, the set heat stop value. (Default value is 17°C)
DURING COOLING	Choose between the following modes: AUTO (According to set temperature), OPEN (Fully open circuit for cooling) or CLOSED .
CONSTANT TEMP	The temperature that the Distr. Circ. 1 demands from the buffer tank and distributes to the heating system. Only applies when the buffer tank is activated and with Distr. Circ. 1 connected.
SETBACK TEMP	The temperature that will apply at temperature setback controlled from the CALENDAR menu.
ROOM FACTOR	Only displayed if an accessory Room temperature sensor is installed. Determines how great an impact the room temperature is to have when calculating the supply temperature. For under floor heating it is recommended that ROOM FACTOR is set to 1, 2 or 3. For radiator heating it is recommended that ROOM FACTOR is set to 2, 3 or 4. Impact: 0 = no impact, 4 = large impact.
POWER LIMITATION	Power Limitation is used to set a maximum power consumption for the heat pump during high energy tariffs.

Warning



High temperatures in an underfloor heating system can damage floor coverage such as parquet and laminate floors. The supply line temperature must not exceed the values recommended by the floor manufacturer.

Adjust the heat curve in the HEATING sub-menu as follows:

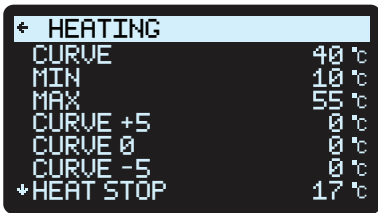

1. Open the HEATING sub-menu in the INFORMATION menu
2. Mark desired parameter using up or down button.
3. Open the parameter by pressing the right button once.
4. Raise or reduce the value with the up or down button.
5. Press the left button three times.

Adjusting ROOM values

The heat curve and therefore the indoor temperature can be affected by changing the "ROOM" value. If the ROOM value is used to affect the system's heat curve, the heat curve does not become steeper or flatter, which the curve becomes if the CURVE value changes, instead the entire heat curve is moved by 3°C for every degree change of the ROOM value.



For a temporary increase or reduction of the indoor temperature, adjust the ROOM value instead of the heat curve.



A heat curve and ROOM temperature set too low will affect the defrost functionality. Make sure to not go below 16°C on the indoor temperature.

Change the ROOM value as follows:

1. Press either the up or down button once to open and change the ROOM value.
2. Raise or reduce the ROOM value using the up or down buttons to change the indoor temperature.
3. Wait ten seconds or press the left button once to exit the menu.

5.3 Distribution circuit 1 and 2

In addition to the main circuit for heating and cooling two distribution circuits can be controlled individually. The same parameters are used for these as in the main circuit (menu HEATING).

5.4 Hot water mode

HOT WATER switched on will enable hot water production. If you should want a prioritization on the amount of hot water and a faster hot water production you should change mode to either **ECO** or **COMFORT**. By activating **TOP-UP** the heat pump can immediately start to heat the water heater using the compressor and electrical auxiliary heater until the tank is fully heated. The **TOP-UP** function has to be reactivated each time it is needed.

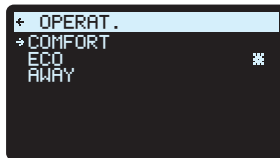
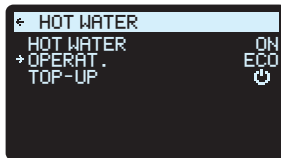

- "**COMFORT**" is the choice for customers with large demands of hot water availability.
- "**ECO**" can be selected as the best compromise between energy efficiency and hot water availability.
- "**AWAY**" is a setting that charges the hot water tank just enough to keeping it maintaining safety functions, like defrost etc. Typically a setting when you're away on vacation.

Remember to inform the end customer that the settings can be changed in the settings menu

5.5 Cooling

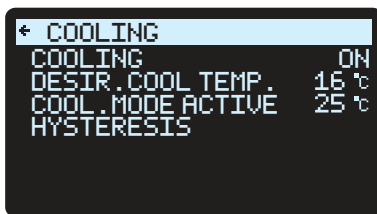

COOLING is used to activate cooling function. DESIR.COOL TEMP. is the desired temperature for cooling. COOL.MODE ACTIVE gives the lowest outdoor temperature with cooling operation is permitted.

Caution



Low temperatures in the system can cause condensation on pipes and pipe connections, which could cause moisture damage to the building. Make sure every pipe and pipe connection is properly insulated if cooling stop temperature is set to below 16°C (default).

5.6 Reading of temperatures

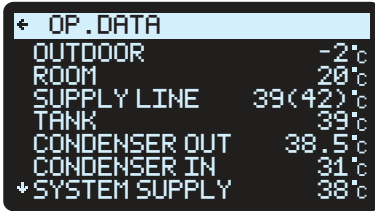

← OP. DATA	
OUTDOOR	-2°C
ROOM	20°C
SUPPLY LINE	39(42)°C
TANK	39°C
CONDENSER OUT	38.5°C
CONDENSER IN	31°C
↓ SYSTEM SUPPLY	38°C

No values can be changed in this menu. The set point value for the supply line is shown within the brackets.

The different temperatures that the installation has are shown here. All temperatures are stored back in time so that they can also be displayed in the form of graphs.

If ROOM shows 20°C the heat curve is unaffected. If ROOM shows higher or lower, this indicates that the heat curve has been adjusted up or down.

5.7 Reading the operating time



← OPERAT. TIME	
COMPRESSOR	0H
HEATING	0H
COOLING	0H
HOT WATER	0H
IMM. HEAT 1	0H
IMM. HEAT 2	0H
↓ IMM. HEAT 3	0H

COMPRESSOR shows the total time in hours that the heat pump has been in operation since installation. HEATING and COOLING shows the time the heat pump has been producing heat and cooling. IMM. HEAT 1, 2 and 3 refer to the immersion heater and its different power stages.

5.8 Calendar

The following functions can be controlled via calendar:

- Blocking hot water production
- Stopping the heat pump at high energy tariff (EVU or POWER LIMITATION)
- Reducing the noise of the fan (gives reduced performance)
- Reducing the temperature in the heating and distribution circuits.

Do as follows:

1. Select which function is to be controlled
2. Select a CALENDAR SETTING (up to 8 can be selected for each function)
3. Select the menu TIME FUNCTION if the function should be over a continuous time period (DATE) or be recurring (DAYS / WEEK).
4. Select start and stop times and date and weekdays in the TIME SETTING menu.

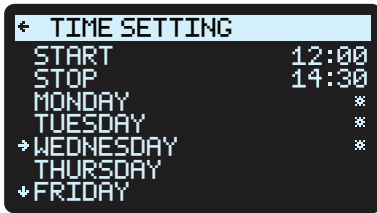

Examples of a recurring calendar control (DAYS / WEEK)

5.8.1 Setting of temperature reduction during night and day

To set the TEMP. REDUCTION, do as follows:

1. Press left arrow (<) to enter the INFORMATION menu.
2. Press (down) button to navigate down to HEATING menu and press right arrow (>) to enter.
3. Press (down) button to navigate down to SETBACK TEMP menu and press right (>) arrow.
4. Set the temperature with the (up) and (down) buttons.
5. Press left arrow (<) to confirm the temperature.
6. Press left arrow (<) to leave the SETBACK TEMP menu and return to the INFORMATION menu

5.8.2 Setting of calendar function (date and time)

To set the date and time (for the calendar function to work properly), do as follows:

1. Press left arrow (<) to enter the INFORMATION menu.
2. Press (down) button to navigate down to CALENDAR and press right arrow (>) to enter.
3. Press the right arrow (>) once to navigate to the time setting (CLOCK).
4. Set today's time with the (up) and (down) buttons and confirm with the right arrow (>).
5. Press (down) button once to navigate down to the date setting (DATE and YEAR).
6. Press the right arrow (>) to enter the DATE setting.
7. Set today's date and year with (up) and (down) buttons.
8. Press right arrow (>) to confirm.
9. Press left arrow (<) to leave the menu and return to INFORMATION menu.

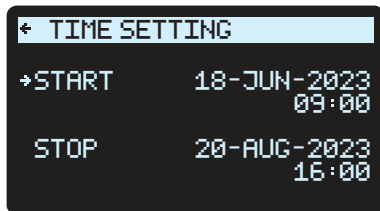

5.8.3 Setting of hot water, EVU or POWER LIMITATION, silent mode and temperature reduction

The time period can either be set to a continuous or a recurring time period.

To set the date and time period for these functions, do as follows:

1. From the main menu, press left arrow (<) to enter the INFORMATION menu.
2. Press (down) button to navigate down to CALENDAR and press right arrow (>) to enter.
3. Press (down) button to navigate down to the function you wish to set (HOT WATER, EVU or POWER LIMITATION, SILENT MODE or TEMP REDUCTION).
4. Press right arrow (>) button once to set Calendar 1 (you can set up to eight different calendars).
5. Press right arrow (>) to enter the CALENDAR setting menu.
6. Press right arrow (>) to enter the TIME FUNCTION menu.
7. Use (up) and (down) buttons to program the function by DATE (continuous) or DAYS/WEEK (recurring).
8. Press right arrow (>) to confirm the selection. An asterisk symbol (*) is shown on the screen.
9. Press left arrow (<) to leave the TIME FUNCTION.
10. Press (down) button once and press right arrow (>) to enter the TIME SETTING menu.
11. Set the start and stop date and time with the (up) and (down) buttons. You can also set the weekday (MONDAY to SUNDAY) if you have selected DAYS/WEEK, see the example below.
12. Press left arrow (<) to leave the menu and return back to INFORMATION menu.

Example for setting SILENT MODE every day between 22:00 and 07:00:

The **FIRST** start and stop time for the desired calendar function:

Scroll down to access all the days of the week:

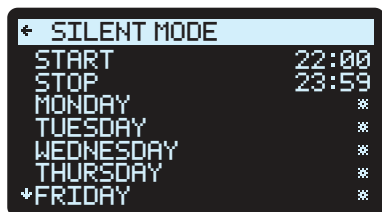

The **SECOND** start and stop time for the desired calendar function:

Scroll down to access all the days of the week:





For the calendar function to work, the STOP time must be set to no later than 23:59 and the START time to no earlier than 00:01. This means if you want the calendar to work over night, for any calendar function, you will have to set TWO start and stop times.

5.9 Alarm history

NAME ALARM displays information about up to 10 alarms with type of alarm, time and date.

6 Regular checks

6.1 Checking operation

During normal operation, the alarm indicator lights green continuously to show that everything is OK. When an alarm is triggered, the display will flash and the indicator will flash green at the same time as a text message is shown in the display.



Regularly check the alarm indicator to ensure that the installation is working correctly. In event of alarm the heat pump will if possible supply heating to the house. Primarily with the compressor, secondarily with the auxiliary heater. Hot water production will stop to indicate that something noteworthy has occurred.

In the event of an alarm this is indicated in the display with the text ALARM and an alarm message/alarm code. Examples of potential alarm messages:

Message	Meaning
OUTDOOR SENSOR	Something have likely happened to the cable connection to the outdoor sensor, the cable itself or the sensor. Check for physical damages. Contact your installer if the alarm persists.
SUPPLY LINE SENSOR	Contact the installer for further assistance.
Other alarm message	Try to reset the alarm as follows. If the alarm remains contact your installer.

Resetting the alarm

For alarms that are not reset automatically, acknowledgement is required. Acknowledge the alarm by setting the heat pump to operating mode OFF and then back to the desired operating mode.

If the alarm remains contact your installer.

NOTE! Don't leave the heat pump in OFF-mode due to risk of freezing damages in low outdoor temperatures.

6.2 Check the supply line water pressure in the heating circuit

The supply line water pressure of the installation must be checked once a month. The pressure gauge must show a value between 0.8-1.5 bar, depending on the system's requirements. If the value is below 0.8 bar, when the water in the heating system is cold, the water must be topped up (applies in the event of an empty expansion tank).

Normal tap water can be used when topping up the heating system. In certain exceptional cases the water quality may be so poor (for example very hard water) that it is not suitable for filling the heating system. If unsure, contact your installer.



Do not use any additives for water treatment in the heating system's water!



The closed expansion tank contains an air filled expansion vessel that absorbs variations in the heating system's volume. Under no circumstances may it be drained of air.

6.3 Checking safety valves

The safety valves in the installation must be checked at least four times a year to prevent lime deposits clogging the mechanism.

The safety valve of the water tank protects the enclosed heater against too high pressure in the water tank. It is mounted on the cold water inlet line, its outlet opening facing downwards. If the safety valve is not checked regularly, the water tank might be damaged. It is quite normal that the safety valve lets out small amounts of water when the water tank is being charged, especially if a lot of hot water was used previously.

The safety valves can be checked by turning the cap a quarter of a turn clockwise until the valve lets out some water through the overflow pipe. If a safety valve does not work properly, it must be replaced. Contact your installer.

The opening pressure of the safety valves is not adjustable.

6.4 In the event of leakage

In the event of leakage in the hot water pipes between the heat pump and water taps, close the shut-off valve on the cold water inlet immediately. Then contact your installer.

6.5 iTec XT: In the event of leakage of R32 refrigerant

iTec XT

The outdoor unit contains a refrigerant that is flammable and should only be handled by trained and certified personnel. In the event of a suspected leakage please contact your installer.

6.6 iTec XTR: In the event of leakage of R290 refrigerant

iTec XTR

The outdoor unit contains a refrigerant that is highly flammable and should only be handled by trained and certified personnel. In the event of a suspected leakage please contact your installer.

6.7 Cleaning the strainer for the heating circuit



The heat pump must be switched off at the main switch before the cleaning can be started.



The strainer must be cleaned twice a year after installation. The interval can be extended if there is evidence that cleaning twice a year is not necessary.



Have a cloth at hand when opening the strainer cover as a small amount of hot water usually escapes.

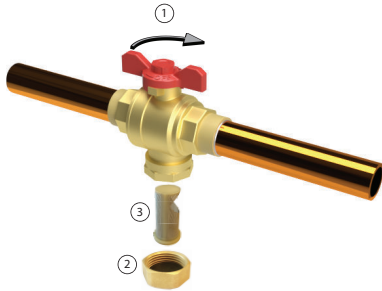

1. Turning handle
2. Dirt strainer
3. Bottom nut with rubber gasket

The strainer can look different depending on model.

Clean the strainer as follows:

1. Switch off the heat pump.
2. Turn the handle to the closed position (see picture above).
3. Unscrew the bottom nut and remove it.
4. Remove the strainer.
5. Rinse the strainer.
6. Reinstall the strainer.
7. Check that the gasket is in place,
8. Screw the nut back into place.
9. Turn the handle to the open position.
10. Start the heat pump.

6.8 Maintenance and cleaning of the outdoor unit

To avoid damages of the outdoor unit make regular checks:

- Keep the area around the outdoor unit ignition free and free from open flame. See chapter: Safety zone for outdoor unit iTec XTR.
- Keep the unit free from debris, like leaves and dirt.
- Check and clean the unit to avoid clogging of the fan grill in the event of a storm or severe weather.
- Make sure there is no buildup of snow or ice around the drain area and fan grill.

To clean the cover of the outdoor unit, use a damp cloth and avoid alkaline cleaning products.

7 Default setting in the control computer

The first column in the table below shows the parameters that can be adjusted by the User. The second column shows settings made at the factory, and the third column the settings made by the installation contractor in connection with installation of the heat pump.

Setting	Factory setting	Any customer specific settings
ROOM	20°C	
OPERAT.	 (OFF)	
CURVE	40°C	
MIN	20°C	
MAX	55°C (45°C for under floor heating)	
CURVE 5	0°C	
CURVE 0	0°C	
CURVE -5	0°C	
HEAT STOP	17°C	
HIGH POWER (N/A for iTec XTR)		

8 Installation protocol

General	
Outdoor unit model	
Serial number	
Indoor unit model	
Serial number	

Pipe installation	
Company	
Contact person	
Telephone number	

Electrical installation	
Company	
Contact person	
Telephone number	

Commissioning	
Company	
Contact person	
Telephone number	
Date final inspection	

9 Checklist

Location

- Surface adjustment
- Drainage

Pipe installation, hot and cold side

- Pipe connections in accordance with the diagram
- Flexible hoses
- Expansion and bleed vessel
- Filter, hot and cold side
- Pipe insulation
- Open radiator valves
- Leak test, hot and cold side

Electrical Installation

- Circuit breaker
- Fuse
- Positioning of the outdoor sensor

Commissioning

- Bleeding, hot and cold side
- Settings control system
- Manual test components
- Manual test different operating conditions
- Noise check
- Function test safety valves
- Function test mixer valve
- Trimming the heating system

Customer information

- Contents of this manual
- Safety precautions
- Controller, function
- Settings and adjustments
- Regular checks
- Reference to service requirement
- Warranties and insurances

10 Service schedule

To achieve best performance and service life we recommend that the heat pump is serviced at a 12 month interval.

Service company*	Service technician's signature*
Date (year-month-day)*	Customer's signature*
Comments*	

Service company*	Service technician's signature*
Date (year-month-day)*	Customer's signature*
Comments*	

Service company*	Service technician's signature*
Date (year-month-day)*	Customer's signature*
Comments*	

Service company*	Service technician's signature*
Date (year-month-day)*	Customer's signature*
Comments*	

Service company*	Service technician's signature*
Date (year-month-day)*	Customer's signature*
Comments*	







Thermia AB
Box 950
SE 671 29 ARVIKA
Phone +46 570 81300
E-mail: info@thermia.com
Internet: www.thermia.com

Thermia can accept no responsibility for possible errors in catalogues, brochures and other printed material. Thermia reserves the right to alter its products without notice. This also applies to products already on order provided that such alterations can be made without subsequential changes being necessary in specifications already agreed. All trademarks in this material are property of the respective companies. Thermia AB and the Thermia AB logotype are trademarks of Thermia AB. All rights reserved.
